

# Montpellier

THE PERFECT BALANCE OF FUNCTION AND STYLE

LAUNDRY - DISHWASHING - COOKING - COOLING

## Installation and Operating Instructions



### **Built in Single Fan Oven**

SFO73B - Full Touch - Black & Stainless

Please read these instructions carefully before attempting to install or use this appliance.  
We recommend that you keep these instructions in a safe place for future reference.



# Welcome

---

Thank you for choosing this Montpellier Built in Single Oven.

Our Ovens have been designed to provide you with the best combination of style, reliability and performance to give you years of trouble-free use.

You may be familiar with a similar product, but please take time to read these instructions carefully before installing or using your Built in Oven to ensure you get the most from your purchase.

We recommend that you keep this manual in a safe place for future reference.

Your Built in Oven is covered by a comprehensive two year Parts & Labour Guarantee. In the unlikely event that you experience a problem with your Oven Pack, you can rest assured that you are fully protected against the cost of repairs for the first 24 months. Please note that any claim must be accompanied by the model reference number, serial number and proof of purchase.

To activate your guarantee, you will need your product serial number. This can be found on the rear of the machine.

There are two ways to register your Guarantee:

- **Online:** Visit the Support page on our website and complete the online Product Registration form. [www.montpellier-appliances.com](http://www.montpellier-appliances.com)
- **By Post:** Form provided, attach a stamp and send it in the post. Don't forget to include your e-mail address so that we can send you the information you need. [montpellier@montpellier-appliances.com](mailto:montpellier@montpellier-appliances.com)



**Note:** We are unable to take registrations over the phone.

---

**2**  
**YEAR**  
**GUARANTEE**  
— PARTS & LABOUR —  
ACROSS ALL OUR MODELS  
**Montpellier**  
www.montpellier-appliances.com

# ACKNOWLEDGMENT

Thank you for purchasing our product. We hope you enjoy using the many features and benefits it provides. Before using this product please study this entire Instruction Manual carefully. Keep this manual in a safe place for future reference. Ensure that other people using the product are familiar with these instructions as well.

## WARNING

- When the oven is first switched on, it may give off an unpleasant smell. This is due to the bonding agent used for the insulating panels within the oven. Please run up the new empty product with the conventional cooking function, 250 °C, 90 minutes to clean oil impurities inside the cavity.
- During the first use, it is completely normal that there will be a slight smoke and odors. If it does occur, you merely have wait for the smell to clear before putting food into the oven.
- Please use the product under the open environment.
- The appliance and its accessible parts become hot during use. Care should be taken to avoid touching heating elements. Children less than 8 years of age shall be kept away unless continuously supervised.
- If the surface is cracked, switch off the appliance to avoid the possibility of electric shock.
- This appliance can be used by children aged from 8 years and above and persons with reduced physical, sensory or mental capabilities or lack of experience and knowledge if they have been given

supervision or instruction concerning use of the appliance in a safe way and understand the hazards involved. Children shall not play with the appliance. Cleaning and user maintenance shall not be made by children without supervision.

- During use, the appliance becomes very hot. Care should be taken to avoid touching heating elements inside the oven.
- Do not allow children to go near the oven when it is operating, especially when the grill is on.
- Ensure that the appliance is switched off before replacing the oven lamp to avoid the possibility of electric shock.
- The means for disconnection must be incorporated in the fixed wiring in accordance with the wiring specifications.
- Children should be supervised to ensure that they do not play with the appliance.
- This appliance is not intended for use by persons (including children) with reduced physical, sensory or mental capabilities, or lack of experience and knowledge, unless they have been given supervision or instruction concerning use of the appliance by person responsible for their safety.
- Accessible parts may become hot during use. Young children should be kept away.
- An all-pole disconnection means must be incorporated in the fixed wiring in accordance with the wiring rules.

- If the supply cord is damaged, it must be replaced by the manufacturer, its service agent or similarly qualified persons in order to avoid a hazard.
- Do not use harsh abrasive cleaners or sharp metal scrapers to clean the oven door glass since they can scratch the surface, which may result in shattering of the glass.
- Only use the temperature probe recommended for this oven.
- A steam cleaner is not to be used.
- The appliances are not intended to be operated by means of an external timer or separate remote-control system.
- Appliance must not be installed behind a decorative door in order to avoid overheating.

## SAFETY HINTS

- Do not use the oven unless you are wearing something on your feet. Do not touch the oven with wet or damp hands or feet.
- For oven: Oven door should not be opened often during the cooking period.
- The appliance must be installed by an authorized technician and put into use. The producer is not responsible for any damage that might be caused by defective placement, and installation by unauthorized personnel.
- When the door or drawer of oven is open do not leave anything on it, you may unbalance your appliance or break the door.
- Some parts of appliance may keep its heat for a long time; it is required to wait for it to cool down before touching onto the points that are exposed to the heat directly.
- If you will not use the appliance for a long time, it is advised to plug it off.

## FITTING THE OVEN INTO THE KITCHEN UNIT

Fit the oven into the space provided in the kitchen unit; it may be fitted underneath a work top or into an upright cupboard. Fix the oven in position by screwing into place, using the two fixing holes in the frame. To locate the fixing holes, open the oven door and look inside. To allow adequate ventilation, the measurements and distances adhered to when fixing the oven.

## IMPORTANT

If the oven is to work properly, the kitchen housing must be suitable. The panels of the kitchen unit that are next to the oven must be made of a heat resistant material. Ensure that the glues of units that are made of veneered wood can withstand temperatures of at least 120 °C. Plastics or glues that cannot withstand such temperatures will melt and deform the unit, once the oven has been lodged inside the units, electrical parts must be completely insulated. This is a legal safety requirement. All guards must be firmly fixed into place so that it is impossible to remove them without using special tools. Remove the back of the kitchen unit to ensure an adequate current of air circulates around the oven. The hob must have a rear gap of at least 45 mm.









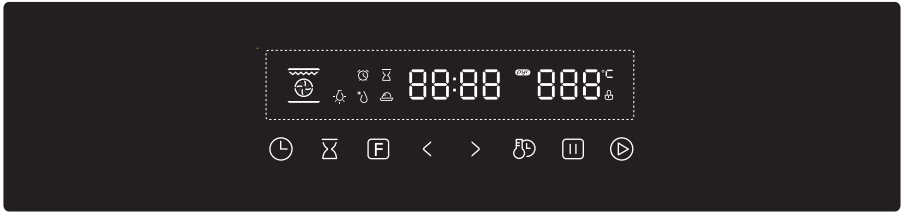

## DECLARATION OF COMPLIANCE

When you have unpacked the oven, make sure that it has not been damaged in any way. If you have any doubts at all, do not use it: contact a professionally qualified person. Keep packing materials such as plastic bags, polystyrene, or nails out of the reach of children because these are dangerous to children.



# PRODUCT DESCRIPTION





Symbol	Function description
	Oven Lamp: Which enables the user to observe the progress of cooking without opening the door. Oven lamp will light for all cooking function, except ECO function.
	Defrost: The circulation of air at room temperature enables quicker thawing of frozen food, (without the use of any heat). It's a gentle but quick way to speed up the defrosting time and thawing of ready-made dishes and cream filled produce etc.
	Bottom heater: A concealed element in the bottom of the oven provides heat. It is mainly used for keeping food warm. The temperature can be set within the range of 60-120°C. The default temperature is 60 °C.
	Conventional cooking: The top and bottom work together to provide convectional cooking. The temperature can be set within the range of 50-250°C. The default temperature is 220°C.
	Convention with fan: Combination of the fan and both heating element provides more even heat penetration, saving up to 30-40% of energy. Dishes are lightly browned on the outside and still moist on the inside. Note: This function is suitable for grilling or roasting big pieces of meat at a higher temperature. The temperature can be set within the range of 50-250°C. The default temperature is 220°C.
	Radiant grilling: The inner grill element switches on and off to maintain temperature. The temperature can be set within the range of 150-240°C. The default temperature is 210°C.
	Double grilling: The inside radiant element and top element are working. The temperature can be set within the range of 150-240°C. The default temperature is 210°C.
	Double grilling with fan: The inside radiant element and top element are working with fan. The temperature can be set within the range of 150-240°C. The default temperature is 210°C.
	Convection: An element around the convection fan provides an additional source of heat for convection style cooking. In convection mode the fan automatically comes on to improve air circulation within the oven and creates an even heat for cooking. The temperature can be set within the range of 50-240°C. The default temperature is 180°C.
	For energy-saved cooking. Cooking the selected ingredients in a gentle manner, and the heat comes from the top and the bottom.



# OPERATION INSTRUCTIONS





## 1. Clock Setting

After connecting the unit to the power, the symbols " 0:00 " will be visible on the display.









- 1> Press "  ", the hour figures will flash.
- 2> Press "< >" to adjust the hour figures, (time should be within 0--23).
- 3> Press "  ", the minutes will flash.
- 4> Press "< >" to adjust the minutes setting, (time should be within 0--59).
- 5> Press "  " to finish the clock settings. ":" will flash, and the time will be illuminated.

Note: The clock is 24 hours. After power on, if not set, the clock will show " 0:00 ".



## 2. Function Setting

- 1> Press "  " to choose the cooking function you require. The related indicator will illuminated .
- 2> Press "< >" to adjust the cooking time and adjust the temperature before press "  " to switch.
- 3> Press "  " to confirm the start of cooking.
- 4> If step 2 is ignored, Press "  " to confirm the start of cooking and the default time is 9 hours, the default temperature will display on the LCD.

NOTE:





- 1> The step quantities for the adjustment time of the coding switch are as follow:  
0--0:30min :step 1 minute    0:30--9:00hour :step 5 minutes
- 2> The step quantities for the adjustment of temperature is 5°C, and "  " "  " can not adjust the temperature.
- 3> Press "< >" to adjust the cooking time when cooking begins. Then press "  " to confirm. If "  " not pressed within 5 seconds, the oven will revert back to the previous time to continue cooking.
- 4> Press "  ", the "  " will show, then press "< >" to adjust the temperature when cooking begins. Then press "  " to start cooking. If "  " not pressed in 5 seconds, the oven will revert back to the previous temperature to continue cooking.

## 3. Lamp Setting

- 1> Press "  " to select the relevant function, then the corresponding icon will be on.
- 2> Press "  " button to start, " 0:00 " and lamp icon "  " will light up, ":" will flash.

## 4. Inquiring Function

In the following states, you can use inquiring function, after 3 seconds return to the current state.

- 1> During working state, if the clock was set, press "  " button to see the current time; if the reminder function was set, press "  " button to see the time of reminder .
- 2> In reminding state, if the clock was set, press "  " button to see the current time.
- 3> In clock display state, if the reservation function was set, press "  " button to see the time of reservation.

## 5. Child lock Function

To Lock : press " ⏸ " and " ⏸ " simultaneously for 3 seconds, there will be a long " beeping " sound and the " 🔒 " will be illuminated.

Lock quitting: press " ⏸ " and " ⏸ " simultaneously for 3 seconds, there will be a long " beeping " sound indicating the child-lock is released.

Note: During working mode, if you want to stop cooking, press stop button quickly. Do not need to long pressing on stop button, it is invalid.

## 6. Reminder Function

The oven has 9 hours reminder, this function will help to remind you to start cooking in a certain time from 1 minute to 9 hours. Only when oven in standby mode, the reminder can be set. Follow below to set the reminder:

- 1> Press reminder setting button " ⏸ " and the display shows " ⌚ " and " AL " ;
- 2> Press " < > " to set the time of reminder.
- 3> Press " ⏸ " to confirm setting. " : " will be flash and the indicator for reminder " ⌚ " will light.  
The time will count down.

Note: The oven buzzer will sound for 10 times after the time back to the zero hour. " ⌚ " symbol disappears on the screen to remind you to start cooking. You can cancel the reminder during setting by pressing the stop button; After the reminder has been set, you can cancel it by pressing stop button twice.

## 7. Reservation Function

Only when the clock has been set. delay function can be used.

In standby mode,

- 1> Press " ⏸ " 2 times, the display shows " ⏸ " and " End ".
- 2> Press " < > " to set the hour of the cooking ending time of reservation.
- 3> Press " ⏸ " button again;
- 4> Press " < > " to set the minute of the cooking ending time of reservation.
- 5> Press " ⏸ " to choose the cooking function you require.
- 6> After set the cooking time and temperature, press " ⏸ " to start.

Note:

Subtract the cooking time from the cooking ending time, you will get the time that oven starts to cook.

## 8. Start/Pause/Cancel Function

- 1> If the cooking time has been set, press " ⏸ " to start cooking. If the cooking is paused, press " ⏸ " to resume cooking.
- 2> During cooking process, press " ⏸ " once to pause the cooking. Press " ⏸ " twice to cancel the cooking.

## 9. Energy-Saving Function

- 1> In waiting state and reminding state , press " ⏪ " for three seconds, the LCD display will go off and set to energy-saving mode.
- 2> If no operation in 10 minutes under waiting state, the LCD display will go off and go into energy-saving mode.
- 3> Under the energy-saving mode, press any key can quit the energy-saving mode.

## 10. Note

- 1> The oven lamp will be on for all functions.
- 2> Once the cooking programme has been set and the " ⏪ " button is not pressed within 5 minutes, the current time will be displayed or turn back to waiting state. The setting program will be invalid.
- 3> The buzzer will sound once when effectively pressed, if not effectively pressed there will be no response.
- 4> The buzzer will sound five times to remind you when cooking has finished.

## ACCESSORIES

Wire shelf : For grill, dishes, cake pan with items for roasting and grilling.

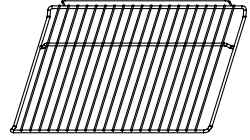

Slider bracket : For cooking larger size food, these shelf support rails on the right and left sides of the oven can be removed, dishes and tray can be put on the oven floor, using functions as Radiant grilling, Double grilling, Double grill with fan.

NOTE: When placing dishes on the oven floor, please DO NOT use functions with bottom heater to prevent heat gathering at bottom.

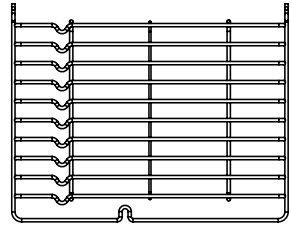

(only for specific models)

Universal pan: For cooking large quantities of food such as moist cakes, pastries, frozen food etc, or for collecting fat/spillage and meat juices.

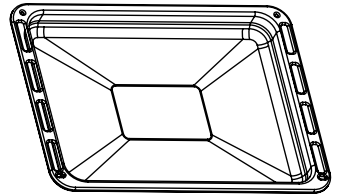

## SHELF PLACEMENT WARNING:

To ensure the oven shelves operate safely, correct placement of the shelves between the side rail is imperative. Shelves and the pan only can be used between the first and fifth layers. The shelves should be used with the right direction, it will ensure that during careful removal of the shelf or tray, hot food items should not slide out.

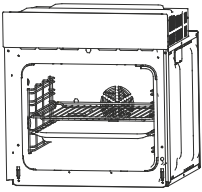

OR

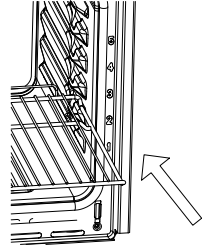
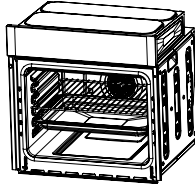

## BULB REPLACEMENT

For replacement, process as follows:

- 1> Disconnect power from the mains outlet or switch off the circuit breaker of the unit's mains outlet.
- 2> Unscrew the glass lamp cover by turning it counter-clockwise (note, it may be stiff) and replace the bulb with a new one of the same type.
- 3> Screw the glass lamp cover back in place.

NOTE: Only use 25-40W/220V-240V , T300°C halogen lamps.

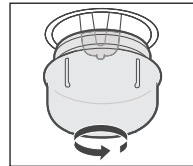

## SECURING THE OVEN TO THE CABINET

1. Fit oven into the cabinet recess.
2. Open the oven door.
3. Secure the oven to the kitchen cabinet with two distance holders " A " which fit the holes in the oven frame and fit the two screws " B " .

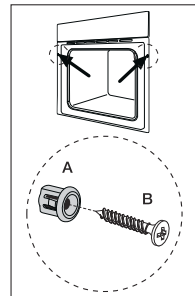

## CONNECTION OF THE OVEN

This appliance has a total Power Rating of 3kW and can be fitted with a 13 Amp plug and plugged into a standard, switchable 13 Amp socket.

Alternatively, the product can be 'hard wired' into a suitable fused spur adjacent to the appliance housing. In this case the product must be installed by a **Qualified Electrician**. Please note that a switchable spur should be accessible above the work surface in order that the power can be turned off.

Electrical Connection Diagram:

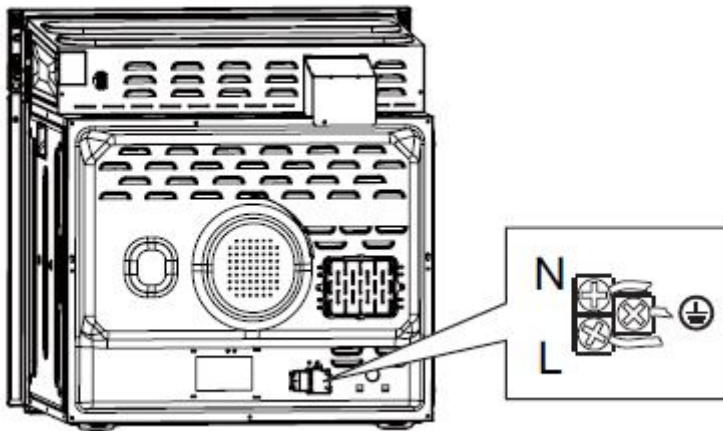

# VENTILATING OPENINGS

When cooking is finished or in pause state or in waiting state, if the oven's center temperature is over 75 degree, the cooling fan will continue working for 15 minutes. Or when the oven's center temperature becomes lower than 75 degree, the cooling fan will stop in advance.

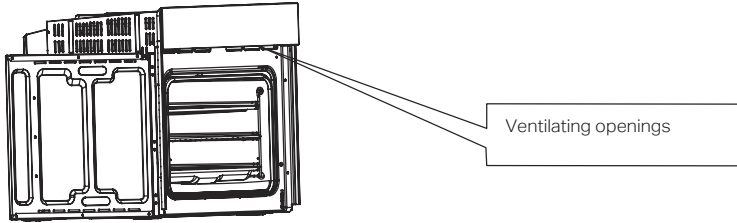

# INSTALLATION

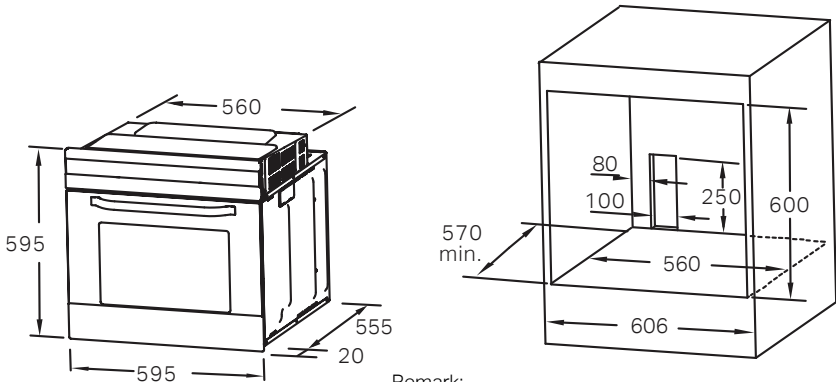

Remark:

- 1. Only plus deviations are admissible for all dimension.
- 2. The cabinet is not include the power switch or socket.

NOTE: The number of accessories included depends on the particular appliance purchased.

# REMOVING THE DOOR FROM OVEN (OPTIONAL)

## Disassembly of oven door components

1. To remove the door, open the door to the maximum angle. Then pull the buckle at the door hinge backward.

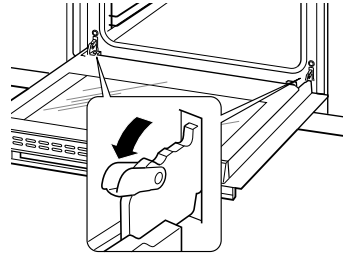

2. Close the door to an angle approximately 30°. Hold the door with one hand on each side. Lift up and slowly pull the door out from the oven.

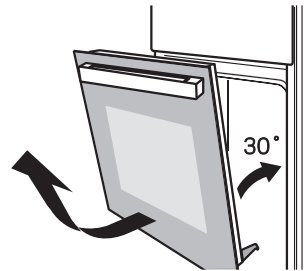

3. Open the door rotation bracket assembly, refer the action in the following picture.

4. Lift up the door outer glass and pull it out, then take the door middle glass out in the same way.

### WARNING:

Don't forcibly pulled out the door and prevent the glass breakage during the dismantling process.

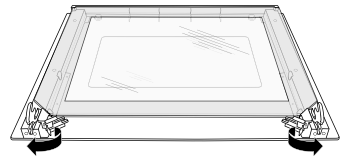

### WARNING:

The hinge springs could loose, causing personal injury.

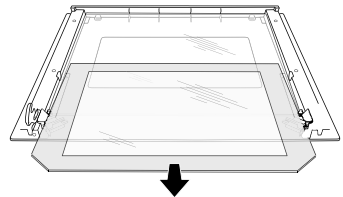

### WARNING:

Do not lift or carry the oven door by the door handle.

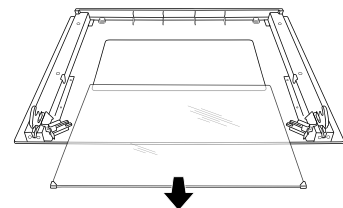



## Recipes for ECO mode

Recipes	Temperature (C°)	Level	Time (min)	Pre-heat
Potato Cheese Gratin	180	1	90-100	No
Cheese Cake	160	1	100-150	No
Meatloaf	190	1	110-130	No

## CLEANING AND MAINTENANCE

For the sake of a good appearance and reliability, keep the unit clean. The modern design of the unit facilitates maintenance to a minimum. The parts of the unit which come into contact with food have to be cleaned regularly.

- Before any maintenance and cleaning, disconnect the power.
- Set all controls in the OFF position.
- Wait until the inside of the unit is not hot but only slightly warm—cleaning is easier than when warm.
- Clean the surface of the unit with a damp cloth, soft brush or fine sponge and then wipe dry. In case of heavy soiling, use hot water with non-abrasive cleaning product.
- For cleaning the glass of the oven door, do not use abrasive cleaners or sharp metal scrapers, these can scratch the surface or lead to the glass being damaged.
- Never leave acidic substances (lemon juice, vinegar) on stainless steel parts.
- Do not use a high pressure cleaner for cleaning the unit. The baking pans may be washed in mild detergent.

This appliance is marked according to the European directive 2012/19/EU on Waste Electrical and Electronic Equipment (WEEE).

By ensuring this product is disposed correctly, you will help prevent potential negative consequences for the environment and human health, which could otherwise be caused by inappropriate waste handling of this product. The symbol on the product indicates that this product may not be treated as household waste. Instead it shall be handed over to the applicable collection point for the recycling of electrical and electronic equipment. Disposal must be carried out in accordance with local environmental regulations for waste disposal. For more detailed information about treatment, recovery and recycling of this product, please contact your local city office, your household waste disposal service or the shop where you purchased the product.



# Here For You

---

## After-sales assistance

If you continue to experience problems with your Built in Oven, please call the Montpellier customer service helpline on: **01759 487839**

Please have all your product details available, including the model number, serial number, date of purchase, and your retailer's details before registering a fault.

The service call cannot progress without this information.

## Your 2 year Manufacturer's guarantee

THIS DOES NOT AFFECT YOUR STATUTORY RIGHTS.

Your new Montpellier appliance carries a free guarantee which protects you against the cost of repairs during the first 24 months from date of purchase provided that:

Any claim is accompanied by evidence of the model reference, model serial number and proof of purchase, such as a Sales Receipt, showing that the appliance was purchased within the 24 months prior to the date of claim.

## What is not covered under the Guarantee

- Any appliance not correctly installed and operated in accordance with the manufacturer's instructions.
- Any appliance that is used for anything other than domestic purposes.
- Any defect caused by accident, misuse, unauthorised modification or inexpert repair.
- Cost of Call-out where a fault cannot be found with the appliance.
- Cost of Call-out for work covering routine maintenance, such as, but not exclusively, cleaning of filters or defrosting.
- Cost of Call-out for work required to correct the alignment of doors following door reversal procedures carried out by you.
- Use of the appliance by anyone other than the Householder.
- Use in any commercial environment.
- Consumable items, such as, but not exclusively, fuses in plugs, bulbs and breakable items which require routine replacement.
- Repair costs incurred that have not been authorised by Montpellier service and/or carried out by a non-approved Montpellier engineer.
- Montpellier Appliances do not accept claims for consequential loss, rusting, corroding, delivery damage or scratches.

## YOUR GUARANTEE IS VALID ONLY IN THE UK.

To register your appliance simply complete the card in your appliance pack and return it to us or alternatively you can register online at [www.montpellier-appliances.com/support](http://www.montpellier-appliances.com/support)

## SERVICE HELP-LINE

Should your appliance develop a fault, please call the Montpellier customer service helpline on: **01759 487839**

Please remember to have all your product details available, including the model number, serial number, date of purchase and your retailer's details before registering a fault.

---





**Montpellier Domestic Appliances Ltd.**

Unit 1, Tewkesbury Retail Park, Northway Lane,  
Tewkesbury, Gloucestershire GL20 8JU

[www.montpellier-appliances.com](http://www.montpellier-appliances.com)



The symbol on the product or on its packaging indicates that this product may not be treated as household waste. Instead it shall be handed over to the applicable collection point for the recycling of electrical and electronic equipment. By ensuring this product is disposed of correctly, you will help prevent potential negative consequences for the environment and human health, which could otherwise be caused by inappropriate waste handling of this product. For more detailed information about recycling of this product, please contact your local city or town council, your household waste disposal service or the shop where you purchased the product.