

Montpellier

THE PERFECT BALANCE OF FUNCTION AND STYLE

LAUNDRY - DISHWASHING - COOKING - COOLING

Installation and Operating Instructions



Induction Hobs - Front Touch Control INT750 & INT905 75/90cm Wide - 99min Timer

Please read these instructions carefully before attempting to install or use this appliance.
We recommend that you keep these instructions in a safe place for future reference.

Welcome

Thank you for choosing this Montpellier Induction Hob.

Our Induction Hobs have been designed to provide you with the best combination of style, reliability and performance to give you years of trouble-free use.

You may be familiar with a similar product, but please take time to read these instructions carefully before installing or using your Hob to ensure you get the most from your purchase.

We recommend that you keep this manual in a safe place for future reference.

2
YEAR
GUARANTEE

— PARTS & LABOUR —

ACROSS ALL OUR MODELS

Montpellier

www.montpellier-appliances.com

Your Induction Hob is covered by a comprehensive two year Parts & Labour Guarantee. In the unlikely event that you experience a problem with your Hob, you can rest assured that you are fully protected against the cost of repairs for the first 24 months . Please note that any claim must be accompanied by the model reference number, serial number and proof of purchase.

To activate your guarantee, you will need your product serial number. This can be found on the rear of the machine.

There are two ways to register your Guarantee:

- **Online:** Visit the Support page on our website and complete the online Product Registration form. www.montpellier-appliances.com
- **By Post:** Simply detach and fill in the form provided, attach a stamp and send it in the post. Don't forget to include your e-mail address so that we can send confirmation through to you.



Note: We are unable to take registrations over the phone.

Congratulations on the purchase of your new Induction Hob.

We recommend that you spend some time to read this Instruction / Installation Manual in order to fully understand how to install correctly and operate it.

For installation, please read the installation section.

Read all the safety instructions carefully before use and keep this Instruction / Installation Manual for future reference.

Safety Warnings

Your safety is important to us. Please read this information before using your cooktop.

Installation

Electrical Shock Hazard

- Disconnect the appliance from the mains electricity supply before carrying out any work or maintenance on it.
- Connection to a good earth wiring system is essential and mandatory.
- Alterations to the domestic wiring system must only be made by a qualified electrician.
- Failure to follow this advice may result in electrical shock or death.

Cut Hazard

- Take care - panel edges are sharp.
- Failure to use caution could result in injury or cuts.

Important Safety Instructions

- Read these instructions carefully before installing or using this appliance.
- No combustible materials or products should be placed on this appliance at any time.
- Please make this information available to the person responsible for installing the appliance.
- In order to avoid a hazard, this appliance must be installed according to these instructions for installation.
- This appliance must be installed and earthed only by a suitably qualified person.
- This appliance should be connected to a circuit which incorporates an isolating switch, providing full disconnection from the power supply.
- Failure to install the appliance correctly could invalidate any warranty or liability claims.

Operation and Maintenance

Electrical Shock Hazard

- Do not cook on a broken or cracked cooktop. If the cooktop surface should break or crack, immediately switch off the appliance at the mains power supply (wall switch) and contact a qualified technician.
- Switch the cooktop off at the wall before cleaning or maintenance.
- Failure to follow this advice may result in electrical shock or death.

Health Hazard

- This appliance complies with electromagnetic safety standards.
- However, persons with cardiac pacemakers or other electrical implants (such as insulin pumps) must consult with their doctor or implant manufacturer before using this appliance to make sure that their implants will not be affected by the electromagnetic field.
- Failure to follow this advice may result in death.

Hot Surface Hazard

- During use the appliance becomes hot. Care should be taken to avoid touching heating elements inside the oven.
- Do not let your body, clothing or any item other than suitable cookware contact the induction glass until the surface is cool.
- Metallic objects such as knives, forks, spoons and lids should not be placed on the hob surface since they can get hot.
- Keep children away.
- Handles of saucepans may be hot to touch. Ensure that the saucepan handles do not overhang other cooking zones that are switched on. Make sure children can't reach the cookware handles.
- Failure to follow this advice could result in burns and scalds.

Cut Hazard

- The razor-sharp blade of a cooktop scraper is exposed when the safety cover is retracted. Use with extreme care and always store safely and out of reach of children.
- Failure to use caution could result in injury or cuts.

Important Safety Instructions

- Never leave the appliance unattended when in use. Boil-over causes smoking and greasy spillovers may ignite.
 - Never use your appliance as a work or storage surface.
 - Never leave any objects or utensils on the appliance.
 - Do not place or leave any magnetisable objects (e.g. credit cards, memory cards) or electronic devices (e.g. computers, MP3 players) near the appliance as they may be affected by its electromagnetic field.
 - Never use your appliance for warming or heating the room.
 - After use, always turn off the cooking zones and the cooktop as described in this manual (i.e. by using the touch controls). Do not rely on the pan detection feature to turn off the cooking zones when you remove the pans.
 - Do not allow children to play with the appliance nor sit, stand or climb on it.
 - Do not store items of interest to children in cabinets above the appliance. Children climbing on the cooktop could be seriously injured.
 - Do not leave children alone or unattended in the area where the appliance is in use.
 - Children or persons with a disability which limits their ability to use the appliance should have a responsible and competent person to instruct them in its use. The instructor should be satisfied that they can use the appliance without danger to themselves or their surroundings.
 - Do not repair or replace any part of the appliance unless specifically recommended in the manual. All other servicing should be done by a qualified technician.
 - Do not use a steam cleaner to clean your cooktop.
 - Do not place or drop heavy objects on your cooktop.
 - Do not stand on your cooktop.
 - Do not use pans with jagged edges or drag pans across the induction glass surface as this can scratch the glass.
 - Do not use scourers or any other harsh abrasive cleaning agents to clean your cooktop as these can scratch the induction glass.
 - This appliance is intended to be used in a household or similar environments such as staff kitchen areas in shops, offices and other residential environments.
 - If the supply cord is damaged, it must be replaced by a special cord or assembly available from the manufacturer or its service agent.
 - **WARNING:** The appliance and its accessible parts become hot during use. Care should be taken to avoid touching heating elements.
- Children less than 8 years of age should be kept away unless continuously supervised.
- Children shall not play with the appliance, cleaning and user maintenance shall not be made by children without supervision.
- This appliance can be used by children aged from 8 years and above and persons with reduced physical, sensory or mental capabilities or lack of experience and knowledge if they have been given supervision or instruction concerning use of the appliance in a safe way and understand the hazards involved.
 - **WARNING:** If the surface is cracked, switch off the appliance to avoid the possibility of an electric shock, for hob surfaces of glass-ceramic or similar material which protect live parts.
 - The appliance is not intended to be operated by means of an external timer or separate remote-control system.
 - **CAUTION:** The cooking process has to be supervised. A short term cooking process has to be supervised continuously.
 - **WARNING:** In order to prevent tipping of the appliance, it must be stabilised prior to installation. Please refer to the installation instructions.
 - **WARNING:** Use only hob guards designed by the manufacturer of the cooking appliance or indicated by the manufacturer of the appliance in the instructions for use as suitable or hob guards incorporated in the appliance. The use of inappropriate guards can cause accidents.
 - This appliance incorporates an earth connection for functional purposes only.
 - **WARNING:** Unattended cooking on a hob with fat or oil can be dangerous and may result in fire. NEVER try to extinguish a fire with water, but switch off the appliance and then cover flame e.g. with a lid or a fire blanket.
 - **WARNING:** Danger of fire: do not store items on the cooking surfaces.



NOTICE: The crystallite glass is still hot after use, please do not touch!

TECHNICAL DATA

| Model | Power supply | Power | | | Size (mm) | Built-in hole Size (mm) |
|--------|---------------------|------------------------|------------------------|------------------------|------------|-------------------------|
| | | Heating area (210mm) | Heating area (180mm) | Heating area (140mm) | | |
| INT750 | AC 220-240V 50Hz | 1800W (boost 2200W) | 1500W (boost 1800W) | 1200W (boost 1500W) | 750x520x77 | 730x490 |
| INT905 | | 1800W (boost 2200W) | 1500W (boost 1800W) | 1200W (boost 1500W) | | |

PRODUCT OVERVIEW

Top View

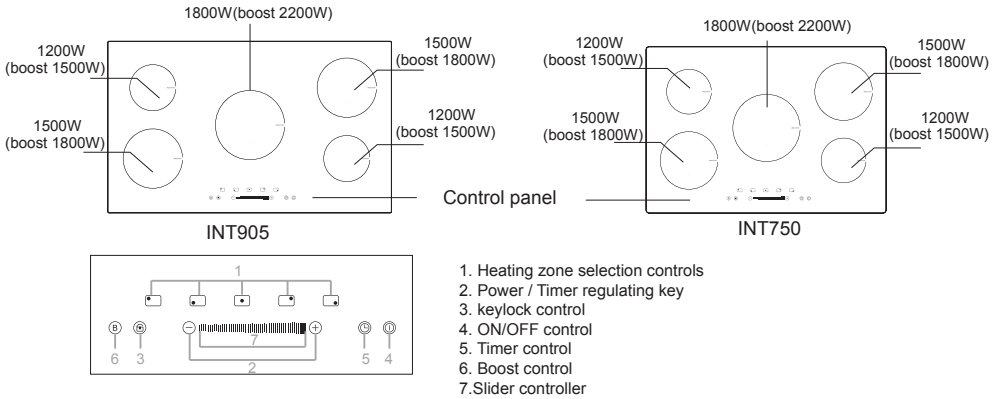

1. Heating zone selection controls
2. Power / Timer regulating key
3. keylock control
4. ON/OFF control
5. Timer control
6. Boost control
7. Slider controller

Before Using Your New Induction Hob

- Read this guide, taking special note of the 'Safety Warnings' section.
- Remove any protective film that may still be on your induction hob.

Using the Touch Controls

- The controls respond to touch so you don't need to apply any pressure.
- Use the ball of your finger, not its tip.
- You will hear a beep each time a touch is registered.
- Make sure the controls are always clean, dry and that there are no objects (e.g. a utensil or a cloth) covering them. Even a thin layer of water may make the controls difficult to operate.

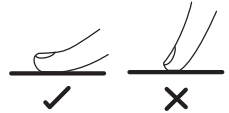

Choosing the Right Cookware

- Only use cookware with a base suitable for induction cooking. Look for the induction symbol on the packaging or on the bottom of the pan.
- You can check whether your cookware is suitable by carrying out a magnet test. Move a magnet towards the base of the pan. If it is attracted, the pan is suitable for induction.
- If you do not have a magnet:

1. Put some water in the pan you want to check.
2. If " " does not flash in the display and the water is heating, the pan is suitable.

- Cookware made from the following materials is not suitable: pure stainless steel, aluminium or copper without a magnetic base, glass, wood, porcelain, ceramic and earthenware.

Do not use cookware with jagged edges or a curved base.

Make sure that the base of your pan is smooth, sits flat on the glass and is the same size as the cooking zone. Using a pot that is slightly wider means energy will be used at its maximum efficiency. If you use a smaller pot, efficiency could be less than expected. Pots with a diameter of less than 140 mm could be undetected by the hob if placed on the larger cooking zone.

Always centre your pan on the cooking zone.

Always lift pans off the induction hob – do not slide as they may scratch the glass.

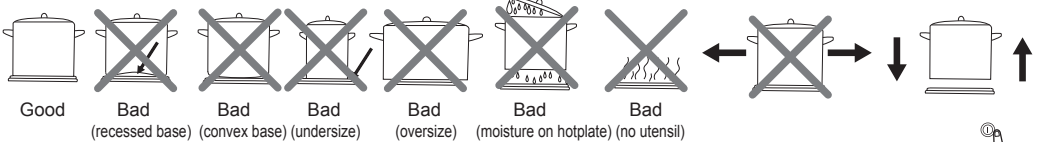

To Start Cooking

1. Touch the ON/OFF control. With the power on, the buzzer beeps once, all displays show " – " or " – – ", indicating that the induction hob has entered the standby mode.
2. Place a suitable pan on the cooking zone that you wish to use.
 - Make sure the bottom of the pan and the surface of the cooking zone are clean and dry.
3. Touch the heating zone selection control and the indicator next to the key will flash.
4. Select a heat setting by touching the "–" or "+" control.
 - If you don't choose a heat setting within 1 minute, the induction hob will automatically switch off. You will need to start again at step 1.
 - You can touch the heating zone selection again and modify the heat setting at any time during cooking.

Slider controller

Switch on the induction hob, press the optional key to select heating zone, the indicator next to the key will flash for 5 seconds, during this period, during this period, it's power can be adjusted from level 2 to 8 by the slider controller; Slide a scontroller from left to right, it is increase steps, slide from right to left to reduce steps.

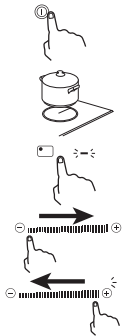

If the Display Flashes “E” Alternately with the Heat Setting

This means that:

- you have not placed a pan on the correct cooking zone or,
- the pan you're using is not suitable for induction cooking or,
- the pan is too small or not properly centred on the cooking zone.

No heating takes place unless there is a suitable pan on the cooking zone.

The display will automatically turn off after 1 minute if no suitable pan is placed on it.

When You Have Finished Cooking

1. Touch the heating zone selection control that you wish to switch off.
2. Turn the cooking zone off by scrolling down to “0”. Make sure the display shows “0” and then “H”.
3. Turn the whole cooktop off by touching the ON/OFF control.
4. Beware of hot surfaces indicator “H” will show which cooking zone is hot to touch. It will disappear when the surface has cooled down to a safe temperature. It can also be used as an energy saving function - if you want to heat further pans, use the hotplate that is still hot.



Locking the Controls

- You can lock the controls to prevent unintended use (for example children accidentally turning the cooking zones on).
- When the controls are locked, all the controls except the ON/OFF control are disabled.

To lock the controls:

Touch the keylock control. The timer indicator will show “Lo”.

To unlock the controls:

1. Make sure the induction hob is turned on.

2. Touch and hold the keylock control for a while.

3. You can now start using your induction hob.

When the hob is in lock mode, all controls are disabled, except the ON/OFF. You can always turn the induction hob off with the ON/OFF control in an emergency, but you would have to unlock the hob first in the next operation.

Overheating Protection

The appliance is equipped with a temperature sensor which can monitor the temperature inside the induction hob.

When an excessive temperature is monitored, the Induction hob will stop operation automatically.

Detection of Small Articles

When an unsuitably sized or non-magnetic pan (e.g. aluminium), or some other small item (e.g. knife, fork, key) has been left on the hob, the display flashes “E” and the hob will automatically go in the standby mode in 1 minute. The fan will keep cooling down the induction hob for a further 2 minutes.

Auto Shutdown Protection

Auto shutdown is a safety protection function for your induction hob. It will automatically turn off after a certain period of time. The default working times for various power levels are shown in the below table:

| Power level | 1 | 2 | 3 | 4 | 5 | 6 | 7 | 8 | 9 |
|------------------------------|---|---|---|---|---|---|---|---|---|
| Default working timer (hour) | 8 | 8 | 8 | 4 | 4 | 4 | 2 | 2 | 2 |

When a pot is removed, the induction hob can stop heating immediately and automatically switch off after 1 minute.



People with a heart pacemaker should consult their doctor before using this unit.

Using the Timer

- You can set it to turn one cooking zone off after the set time is up.
- You can set the timer up to 99 minutes.

Setting the Timer to Turn off One Cooking Zone

1. Touch the heating zone selection control that you want to set the timer for.
2. Touch timer control, the minder indicator will start flashing and “30” will show in the timer display.
3. Set the time by touching the “+” and “-” buttons.

Hint: Touch the “-” or “+” control of the timer once - time will decrease or increase by 1 minute.

Touch and hold the “-” or “+” control of the timer - time will decrease or increase by 10 minutes.

4. Touch the “-” control to reduce the time outstanding to zero or press the “timer control” when the “00” shows in the minute display to cancel the timer.

5. When the time is set, it will begin to count down immediately. The display will show the remaining time and the timer indicator will flash for 5 seconds.

NOTE: The red dot next to power level indicator will illuminate, indicating that zone is selected.

6. When cooking timer expires, the corresponding cooking zone will switch off automatically.

7. Timer for multiple heating areas delay off, the shortest delay off time will be shown on display. If want to check remained delay off time of other heating area, you should press button for different heating area.

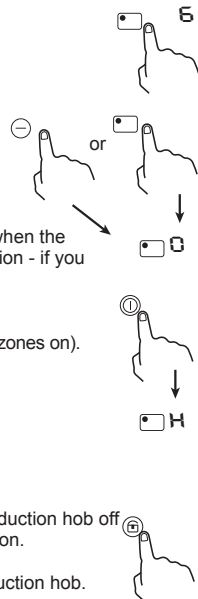

Other cooking zones will keep operating if they have been turned on previously.

Boost Control

During hob working, touching the heating zone selection control, then touching boost control, the buzzer beeps once, "P" will show in the display, the hob enters BOOST function, the power increases to be 1500W/1800W/2200W. BOOST function will run for 5 minutes, then quit automatically and the hob return previous running status. In BOOST mode, touching "BOOST" button, the hob quits BOOST function and then return previous running status.



Cooking Guidelines



Take care when frying as the oil and fat heat up very quickly, particularly if you're using the "Boost" function. At extremely high temperatures oil and fat will ignite spontaneously and this presents a serious fire risk.

Heat Settings

The settings below are guidelines only. The exact setting will depend on several factors, including your cookware and the amount you are cooking. Experiment with the induction hob to find the settings that best suit you.

| Heat setting | Suitability |
|--------------|---|
| 1-2 | <ul style="list-style-type: none">● Delicate warming for small amounts of food● Melting chocolate, butter, and foods that burn quickly● Gentle simmering● Slow warming |
| 3-4 | <ul style="list-style-type: none">● Reheating● Rapid simmering● Cooking rice |
| 5-6 | <ul style="list-style-type: none">● Pancakes |
| 7-8 | <ul style="list-style-type: none">● Cooking pasta |
| 9 | <ul style="list-style-type: none">● Stir-frying● Searing● Bringing soup to the boil● Boiling water |

Care and cleaning

1. Everyday soiling on glass (fingerprints, marks, stains left by food or non-sugary spillovers on the glass).

- 1) Switch off the power to the cooktop.
- 2) Apply a cooktop cleaner while the glass is still warm (but not hot!)
- 3) Rinse and wipe dry with a clean cloth or paper towel.
- 4) Switch the power to the cooktop back on.

NOTE:

- When the power to the cooktop is switched off, there will be no hot surface indication but the cooking zones may still be hot! Take extreme care.
- Heavy-duty or some nylon scourers and harsh/abrasive cleaning agents may scratch the glass surface, so please do check that they are suitable for induction hob care before use.
- Never leave cleaning residue on the cooktop: the glass may become stained.

2. Boil-overs, melts and hot sugary spills on the glass

Remove these immediately with a palette knife or razor blade scraper suitable for induction glass cooktops but beware of hot cooking zone surfaces:

- 1). Switch off the power to the cooktop via the isolation switch.
- 2). Hold the blade or utensil at a 30° angle and scrape the soiling or spill to a cool area of the cooktop.
- 3). Clean the soiling or spill up with a dish cloth or paper towel.
- 4). Follow steps 2 to 4 for everyday soiling on glass above.

NOTE:

- Remove stains left by melts and sugary food or spillovers as soon as possible. If left to cool on the glass, they may be difficult to remove or even permanently damage the glass surface.
- Cut hazard: when the safety cover is retracted, use with extreme care and always store safely and out of reach of children.

3. Spillovers on the touch controls

- 1). Switch off the power to the cooktop.
- 2). Soak up the spill.
- 3). Wipe the touch control area with a clean damp sponge or cloth.
- 4). Wipe the area completely dry with a paper towel.
- 5). Switch the power to the cooktop back on.

NOTE: The cooktop may beep and turn itself off, and the touch controls may not function while there is liquid on them. Make sure you wipe the touch control area dry before turning the cooktop back on.

4. Disassembly bottom base (INT905)

4 bigger screws need to be removed first before bottom base disassembly. (Bottom base removal need to be done by professional person. Normal user is not allowed to disassembly bottom base)

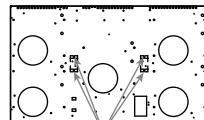

Screws need to be removed

Hints and Tips

1. The induction hob cannot be turned on.

Make sure the induction hob is connected to the power supply and that it is switched on.

Check whether there is a power outage in your home or local area. If you've checked everything and the problem persists, call a qualified technician.

2. The touch controls are unresponsive.

The controls are locked: Unlock the controls. See section using your induction cooktop for instructions.

3. The touch controls are difficult to operate.

There may be a slight film of water over the controls or you may be using the tip of your finger when touching the controls:

Make sure the touch control area is dry and use the ball of your finger when touching the controls.

4. The glass is being scratched.

Tough-edged cookware. Unsuitable, abrasive scourer or cleaning products being used: Use cookware with flat and smooth bases. See "Choosing the Right Cookware" and "Care and Cleaning" for further advice.

5. Some pans make crackling or clicking noises.

This may be caused by the construction of your cookware (layers of different metals vibrating differently): This is normal, the noise should quieten down or disappear completely.

6. The induction hob makes a low humming noise when used on a high heat setting.

This is caused by the technology of induction cooking: This is normal, the noise should quieten down or disappear completely when you decrease the heat setting.

7. Fan noise coming from the induction hob.

A cooling fan built into your induction hob has come on to prevent the electronics from overheating. It may continue to run even after you've turned the induction hob off: This is normal and needs no action. Do not switch the power to the induction hob off at the wall while the fan is running.

8. Pans do not become hot and " U " appears in the display.

The induction hob cannot detect the pan because it is not suitable for induction cooking. The induction hob cannot detect the pan because it is too small for the cooking zone or not properly centred on it: Use cookware suitable for induction cooking. See section "Choosing the Right Cookware".

Centre the pan and make sure that its base matches the size of the cooking zone.

9. The induction hob or a cooking zone has turned itself off unexpectedly, a tone sounds and an error code is displayed (typically alternating with one or two digits in the cooking timer display).

Technical fault: Please note down the error letters and numbers, switch the power to the induction hob off at the wall, and contact a qualified technician.

Failure Display and Inspection

If an abnormality comes up, the induction hob will automatically enter the protective state and display corresponding protective codes:

| Problem | Possible causes | What to do |
|-------------------------------------|--|---|
| The appliance does not work | Break in power supply | Please check the main power is normal; if the leakage protection switch is off; if there is a blown fuse, replace it with a new one; if the main power is normal, check if the plug is connect with socket appropriately; If the hob is wire connection type, disconnect the power, check if the wire is loose; disconnect the power, check if main plug is off; Exclude above reasons, should be appliance fault, send it to service center for repairing. |
| During heating, the unit stop work. | Delay off timer activates. | Please check if set delay off function. If set delay off function, the unit will stop once delay off time out. |
| U | No pan or pan unsuitable | No pan, please put proper pan. PCB synchronization or drive circuit fault, please send the appliance to service center for repairing. |
| E2 | Input power too low | Low voltage, voltage of the main power is less 180V. Please check if voltage of the main power is normal. Once voltage of the main power returns normal, re-start the unit. Voltage of PCB fault, please send the unit to service center for repairing. |
| E1 | Input power too high | High voltage, voltage of the main power exceeds 250V. Please check if voltage of the main power is normal. Once voltage of the main power returns normal, re-start the unit. Voltage of PCB fault, please send the unit to service center for repairing. |
| F3 | Thermistor of coil short circuit | Sensor of coil thermistor connection error. Or detection part of PCB coil thermistor failure, send to service center for repairing. |
| F4 | Thermistor of coil open circuit | Sensor of coil thermistor connection error. Or detection part of PCB coil thermistor failure, send to service center for repairing. |
| E5 | Too high temperature of IGBT thermistor. | Too high temperature of IGBT thermistor, air outlet is blocked. Open air outlet, re-start the unit. If still unsolved, it is possible that cooling fan connection error, cooling fan damaged, or drive circuit of fan failure, send to service center for repairing. IGBT temperature sensor open circuit /short circuit. Temperature detection part of PCB IGBT failure, send to service center for repairing. |
| E3 | Too high temperature of coil thermistor. | Too high temperature on induction glass surface, please check if there is no water in pan. After treatment, connect with power again. If still unsolved, it is possible that sensor of cooktop failure, send to service center for repairing. |
| F9 | IGBT thermistor short circuit | Senor of IGBT thermistor connection error. Or detection part of IGBT PCB sensor failure, send to service center for repairing. |
| FA | IGBT thermistor open circuit | Senor of IGBT thermistor connection error. Or detection part of IGBT PCB sensor failure, send to service center for repairing. |

The above are the judgment and inspection of common failures.

Please do not disassemble the unit by yourself to avoid any danger or damage to the induction hob.

Installation

Selection of Installation Equipment

Cut out the work surface according to the sizes shown in the drawing.

For the purpose of installation and use, a minimum of 5cm space should be preserved around the hole.

Ensure the thickness of the work surface is at least 35mm. Please select a heat-resistant work surface material to avoid deformation caused by the heat radiation from the hotplate.

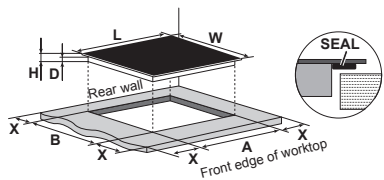

INT750

| L(mm) | W(mm) | H(mm) | D(mm) | A(mm) | B(mm) | X(mm) |
|-------|-------|-------|-------|-------|-------|---------|
| 750 | 520 | 77 | 72 | 730 | 490 | 50 mini |

INT905

| L(mm) | W(mm) | H(mm) | D(mm) | A(mm) | B(mm) | X(mm) |
|-------|-------|-------|-------|-------|-------|---------|
| 860 | 520 | 77 | 72 | 830 | 490 | 50 mini |

The hob has a special seal which prevents liquid from entering the cabinet. Follow these instructions in order to correctly apply this seal: Detach the seals from their backing. Turn the hob over and correctly position the seal under the edge of the hob so that the outer part of the seal perfectly matches the outer edge of the hob. Fix the seal to the hob evenly and securely, pressing it firmly in place.

Make sure the induction hob is well ventilated and the air inlet and outlet are not blocked. Ensure the induction hob is in good working order.



Note: The distance between the hotplate and the cupboard above should be at least 760mm.

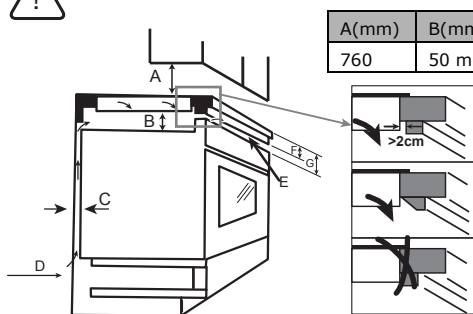

Note: There must be a 560x5mm opening in the front (position E) to dissipate the air.



After installation, ensure the airflow opening is not blocked by the worktop.

Before you install the hob, make sure that:

- The work surface is square and level, and that no structural units interfere with the space requirements.
- The work surface is made of a heat-resistant material.
- If the hob is installed above an oven, the oven has a built-in cooling fan.
- The installation will comply with all clearance requirements and applicable standards and regulations.
- A suitable isolating switch providing full disconnection from the mains power supply is incorporated in the permanent wiring, mounted and positioned to comply with the local wiring rules and regulations. The isolating switch must be of an approved type and provide a 3 mm air gap contact separation in all poles (or in all active [phase] conductors if the local wiring rules allow for this variation of the requirements).
- The isolating switch will be easily accessible after installation.
- You consult local building authorities and by-laws if in doubt regarding installation.
- You use heat-resistant materials (such as ceramic tiles) for the wall surfaces surrounding the hob.

When you have installed the hob, make sure that:

- The power supply cable is not accessible through cupboard doors or drawers.
- There is adequate flow of fresh air from outside the cabinets to the base of the hob.
- If the hob is installed above a drawer or cupboard space, the hob bottom temperature may be too high, in order to prevent hand or other flammable /combustion contact, a thermal protection barrier is installed below the base of the hob.
- The isolating switch is easily accessible.

Before locating the fixing brackets

The unit should be placed on a stable, smooth surface to prevent damage. Do not apply force onto the controls protruding from the hob.

Adjusting the bracket position

Fix the hob on the work surface by screwing 4 brackets on the bottom of hob (see picture) after installation.

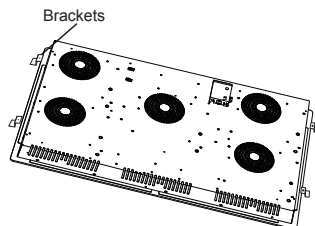

Cautions

1. The induction hot must be installed by qualified personnel or technicians.
2. The hob must not be installed directly above a dishwasher, fridge, freezer, washing machine or a dryer as the humidity may damage the hob electronics.
3. The induction hot must be installed in a way that better heat radiation can be ensured to enhance its reliability.
4. The wall and induced heating zone above the worksurface must withstand heat generated by the hob.
5. To avoid any damage, the sandwich layer and adhesive must be resistant to heat.



Connecting the hob to the mains power supply

This hob must be connected to the mains power supply only by a suitably qualified person.

Before connecting the hob to the mains power supply, check that:

1. the domestic wiring system is suitable for the power drawn by the hob.
2. the voltage corresponds to the value given in the rating plate
3. the power supply cable sections can withstand the load specified on the rating plate.

To connect the hob to the mains power supply, do not use adapters, reducers, or branching devices, as they can cause overheating and fire.

The power supply cable must not touch any hot parts and must be positioned so that its temperature will not exceed 75°C at any point. Check with an electrician whether the domestic wiring system is suitable without alterations. Any alterations must only be made by a qualified electrician.

The power supply should be connected in compliance with the relevant standard, or a single-pole circuit breaker. The method of connection is shown below.

| | | |
|---|--|--|
| <p style="text-align: center;">CONNECTION DIAGRAM</p> <p style="text-align: center;">Caution! Voltage of heating elements 220-240V Caution! In the event of any connection the safety Wire must be connected to the E terminal.</p> | | <p>Recommended type of connection lead</p> |
| <p>For 220-240V earthed one-phase connection, bridges connect L①-②-③ terminals and N④-⑤ terminals, safety wire to .</p> | | |

- If the cable is damaged or to be replaced, the operation must be carried out by a service agent or a suitably qualified professional.
- If the appliance is being connected directly to the mains, an omnipolar circuit breaker must be installed with a minimum opening of 3mm between contacts.
- The installer must ensure that the correct electrical connection has been made and that it is compliant with all applicable standards and safety regulations.
- The cable must not be bent or compressed.
- The cable must be checked regularly and replaced by authorised technicians only.

| | |
|--|---|
| | <p>This appliance is labelled in compliance with European directive 2012/19/EC for Waste Electrical and Electronic Equipment (WEEE). By ensuring that this appliance is disposed of correctly, you will help prevent any possible harm to the environment and to human health which might otherwise be caused if disposed of in the wrong way.</p> <p style="text-align: center;">The symbol on the product indicates that it may not be treated as normal household waste. It should be taken to a collection point for the recycling of electrical and electronic goods.</p> <p>This appliance requires specialist waste disposal. For further information regarding the treatment, recovery and recycling of this product, please contact your local council, household waste disposal service or the shop where you purchased the product.</p> <p>For more detailed information about treatment, recovery and recycling of this product, please contact your local council, household waste disposal service or the shop where you purchased the product.</p> |
|--|---|

| | Symbol | Value | | Unit |
|--|--------------------------------|--|--|-------|
| Model identification | -- | INT750 | INT905 | |
| Type of hob | -- | Built-in hob | Built-in hob | |
| Number of electric cooking zones and/or areas | -- | 5 | 5 | |
| Heating technology (induction cooking zones and cooking areas, radiant cooking zones, solid plates) | -- | Induction zones | Induction zones | |
| For circular cooking zones or area: diameter of useful surface area per electric heated cooking zone, rounded to the nearest 5 mm | ∅ | 21,0 cm 18,0 cm 14,0 cm | 21,0 cm 18,0 cm 14,0 cm | cm |
| For non-circular cooking zones or areas: length and width of useful surface area per electric heated cooking zone or area, rounded to the nearest 5 mm | L, W | N/A | N/A | cm |
| Energy consumption per cooking zone or area calculated per kg | EC _{electric cooking} | Φ210 zone: 202 Φ180 zone: 187 Φ140 zone: 189 | Φ210 zone: 202 Φ180 zone: 187 Φ140 zone: 189 | Wh/kg |
| Energy consumption for the hob calculated per kg | EC _{electric hob} | 191 | 191 | Wh/kg |

Here For You

After-sales assistance

If you continue to experience problems with your Induction Hob, please call the Montpellier customer service helpline on: **01759 487839**.

Please have all your product details available, including the model number, serial number, date of purchase, and your retailer's details before registering a fault.

The service call cannot progress without this information.

Your 2 year Manufacturer's guarantee

THIS DOES NOT AFFECT YOUR STATUTORY RIGHTS.

Your new Montpellier appliance carries a free guarantee which protects you against the cost of repairs during the first 24 months from date of purchase provided that:

Any claim is accompanied by evidence of the model reference, model serial number and proof of purchase, such as a Sales Receipt, showing that the appliance was purchased within the 24 months prior to the date of claim.

What is not covered under the Guarantee

- Any appliance not correctly installed and operated in accordance with the manufacturer's instructions.
- Any appliance that is used for anything other than domestic purposes.
- Any defect caused by accident, misuse, unauthorised modification or inexpert repair.
- Cost of Call-out where a fault cannot be found with the appliance.
- Cost of Call-out for work covering routine maintenance, such as, but not exclusively, cleaning of filters or defrosting.
- Cost of Call-out for work required to correct the alignment of doors following door reversal procedures carried out by you.
- Use of the appliance by anyone other than the Householder.
- Use in any commercial environment.
- Consumable items, such as, but not exclusively, fuses in plugs, bulbs and breakable items which require routine replacement.
- Repair costs incurred that have not been authorised by Montpellier and/or carried out by a non-approved Montpellier engineer.

YOUR GUARANTEE IS VALID ONLY IN THE UK & ROI.

To register your appliance simply complete the card in your appliance pack and return it with a stamp affixed or alternatively you can register online at www.montpellier-appliances.com/support

SERVICE HELP-LINE

Should your appliance develop a fault, please call the Montpellier customer service helpline on: **01759 487839**.

Please remember to have all your product details available, including the model number, serial number, date of purchase and your retailer's details before registering a fault.

Your service call cannot progress without this information.

Montpellier Domestic Appliances Ltd.

Unit 1, Tewkesbury Retail Park, Northway Lane,
Tewkesbury, Gloucestershire GL20 8JU

www.montpellier-appliances.com



The symbol on the product or on its packaging indicates that this product may not be treated as household waste. Instead it shall be handed over to the applicable collection point for the recycling of electrical and electronic equipment. By ensuring this product is disposed of correctly, you will help prevent potential negative consequences for the environment and human health, which could otherwise be caused by inappropriate waste handling of this product. For more detailed information about recycling of this product, please contact your local city office, your household waste disposal service or the shop where you purchased the product.